

// AP\_120

# HOW TO BUILD YOUR LIGHTBOX AP\_120



SCAN DEN QR-CODE FÜR DIE VIDEOANLEITUNG  
SCAN THE QR-CODE FOR THE VIDEO INSTRUCTION

## // AP\_120

## LIEFERUMFANG / SCOPE OF DELIVERY



LIGHTBOX AP\_120 MODUL  
IN1.1000  
M2.IN1.120.1000.G  
BREITE 1000 MM  
HÖHEN 2150 / 2460 / 2960 MM  
60 WATT LED POWER  
SYSTEMVERPACKUNG  
SCHAUMINLAY MIT ORDNUNGSSYSTEM  
IN KARTONAGE  
PACKVOLUMEN 1 STÜCK  
1280 x 140 x 370MM  
GEWICHT 15 KG

WIDTH 1000 MM  
HIGHT 2150 / 2460 / 2960 MM  
60 WATT LED POWER  
SYSTEM PACKAGING  
FOAM INLAY WITH ORGANIZATION  
SYSTEM IN CARDBOARD BOX  
PACK VOLUME 1 PIECE  
1280 x 140 x 370MM  
WEIGHT 15 KG

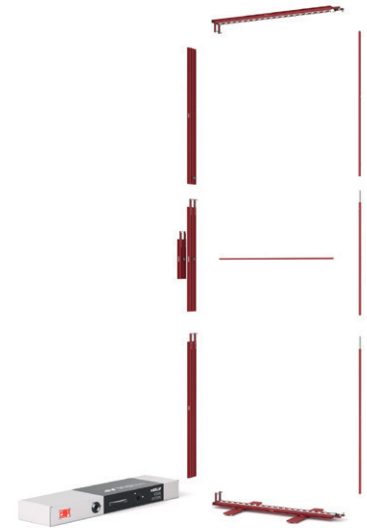

LIGHTBOX AP\_120 MODUL  
IN2.1000  
M2.IN2.120.1000.R  
BREITE 1000 MM  
HÖHEN 2150 / 2460 / 2960 MM  
SYSTEMVERPACKUNG  
SCHAUMINLAY MIT ORDNUNGSSYSTEM  
IN KARTONAGE  
PACKVOLUMEN 1 STÜCK  
1280 x 140 x 370MM  
GEWICHT 15 KG

WIDTH 1000 MM  
HIGHT 2150 / 2460 / 2960 MM  
SYSTEM PACKAGING  
FOAM INLAY WITH ORGANIZATION  
SYSTEM IN CARDBOARD BOX  
PACK VOLUME 1 PIECE  
1280 x 140 x 370MM  
WEIGHT 15 KG



LIGHTBOX AP\_120 MODUL  
IN3.1000  
M2.IN3.120.1000.B  
BREITE 1000 MM  
HÖHEN 2150 / 2460 / 2960 MM  
SYSTEMVERPACKUNG  
SCHAUMINLAY MIT ORDNUNGSSYSTEM  
IN KARTONAGE  
PACKVOLUMEN 1 STÜCK  
1280 x 140 x 370MM  
GEWICHT 8 KG

WIDTH 1000 MM  
HIGHT 2150 / 2460 / 2960 MM  
SYSTEM PACKAGING  
FOAM INLAY WITH ORGANIZATION  
SYSTEM IN CARDBOARD BOX  
PACK VOLUME 1 PIECE  
1280 x 140 x 370MM  
WEIGHT 8 KG

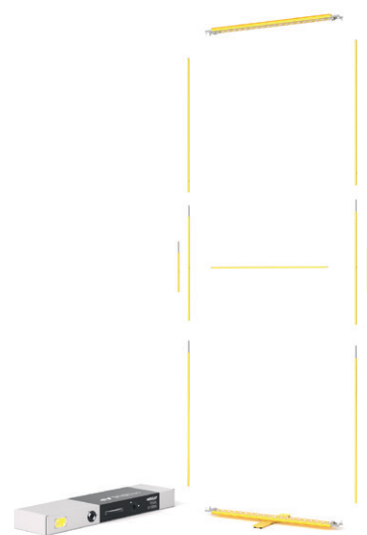

LIGHTBOX AP\_120 MODUL  
IN4.1000  
M2.IN4.120.1000.Y  
BREITE 1000 MM  
HÖHEN 2150 / 2460 / 2960 MM  
SYSTEMVERPACKUNG  
SCHAUMINLAY MIT ORDNUNGSSYSTEM  
IN KARTONAGE  
PACKVOLUMEN 1 STÜCK  
1280 x 140 x 370MM  
GEWICHT 10 KG

WIDTH 1000 MM  
HIGHT 2150 / 2460 / 2960 MM  
SYSTEM PACKAGING  
FOAM INLAY WITH ORGANIZATION  
SYSTEM IN CARDBOARD BOX  
PACK VOLUME 1 PIECE  
1280 x 140 x 370MM  
WEIGHT 10 KG

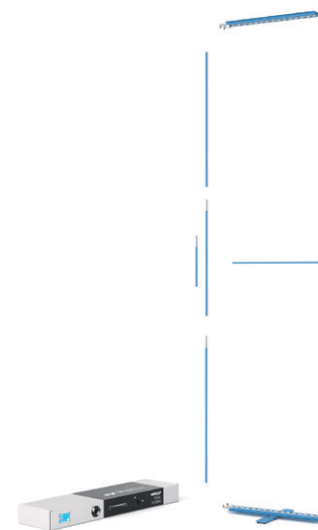

LIGHTBOX AP\_120 MODUL  
IN3.750  
M2.IN3.120.0750.B  
BREITE 750 MM  
HÖHEN 2150 / 2460 / 2960 MM  
SYSTEMVERPACKUNG  
SCHAUMINLAY MIT ORDNUNGSSYSTEM  
IN KARTONAGE  
PACKVOLUMEN 1 STÜCK  
1280 x 140 x 370MM  
GEWICHT 7,5 KG

WIDTH 1000 MM  
HIGHT 2150 / 2460 / 2960 MM  
SYSTEM PACKAGING  
FOAM INLAY WITH ORGANIZATION  
SYSTEM IN CARDBOARD BOX  
PACK VOLUME 1 PIECE  
1280 x 140 x 370MM  
WEIGHT 7,5 KG

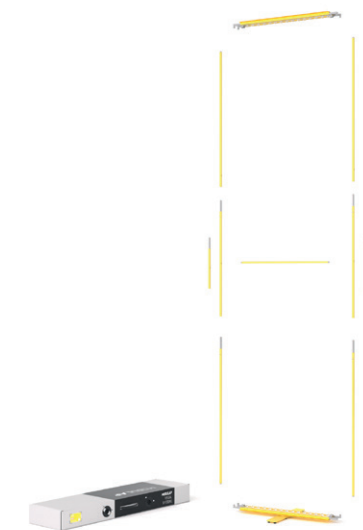

LIGHTBOX AP\_120 MODUL  
IN4.750  
M2.IN4.120.0750.Y  
BREITE 750 MM  
HÖHEN 2150 / 2460 / 2960 MM  
SYSTEMVERPACKUNG  
SCHAUMINLAY MIT ORDNUNGSSYSTEM  
IN KARTONAGE  
PACKVOLUMEN 1 STÜCK  
1280 x 140 x 370MM  
GEWICHT 8,5 KG

WIDTH 1000 MM  
HIGHT 2150 / 2460 / 2960 MM  
SYSTEM PACKAGING  
FOAM INLAY WITH ORGANIZATION  
SYSTEM IN CARDBOARD BOX  
PACK VOLUME 1 PIECE  
1280 x 140 x 370MM  
WEIGHT 8,5 KG

## // AP\_120

Übersicht möglicher Rahmentypen und Breiten. Der Stromanschluss erfolgt über das Modul IN1. Ab 4 Meter werden zwei IN1 Module benötigt, die jeweils außen rechts und links positioniert werden.

Overview of possible frame types and widths. Power is connected via the IN1 module. For lengths of 4 m or more, two IN1 modules are required, which are positioned on the outside right and left respectively.

### BIS 4 METER BREITE



RASTER 1000

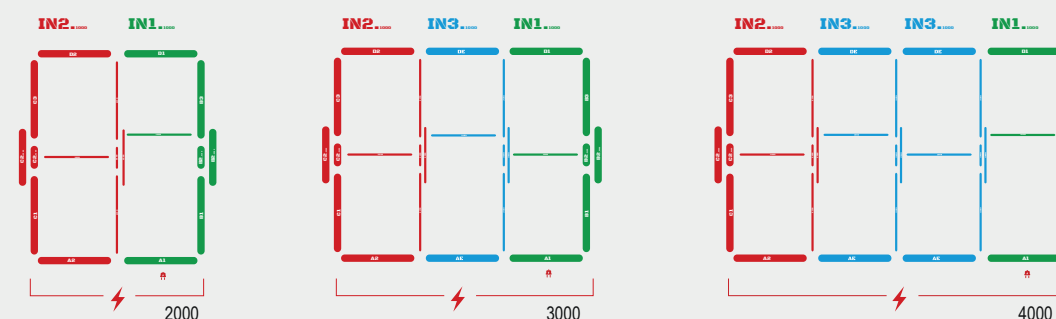

RASTER 750 MM

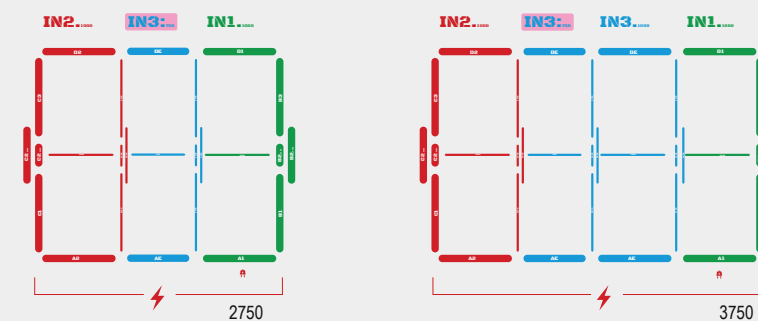

RASTER 500 MM

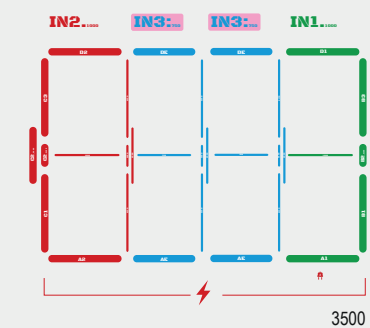

# // AP\_120

Übersicht möglicher Rahmentypen und Breiten. Der Stromanschluss erfolgt über das Modul IN1. Ab 4 Meter werden zwei IN1 Module benötigt, die jeweils außen rechts und links positioniert werden.

Overview of possible frame types and widths. Power is connected via the IN1 module. For lengths of 4 m or more, two IN1 modules are required, which are positioned on the outside right and left respectively.

## AB 4 METER BREITE



RASTER 1000

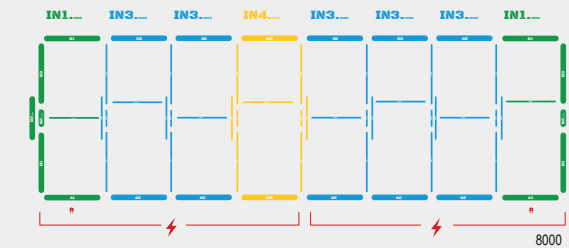
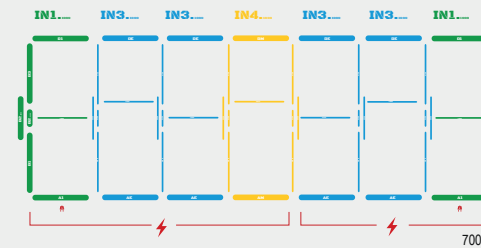
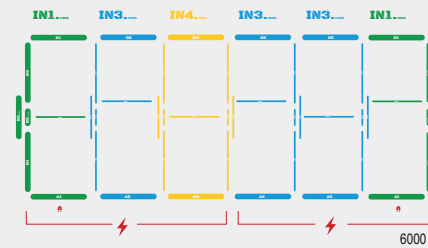
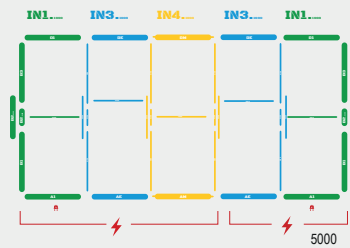

RASTER 750 MM

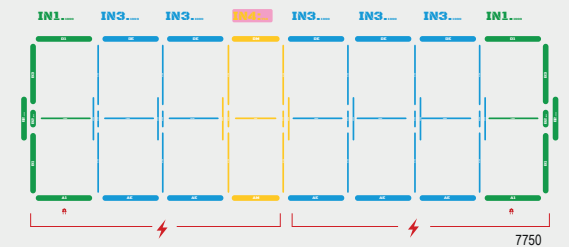
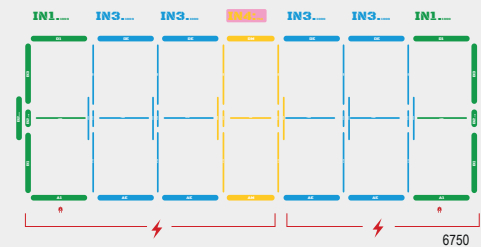
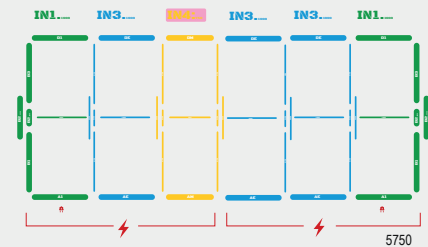
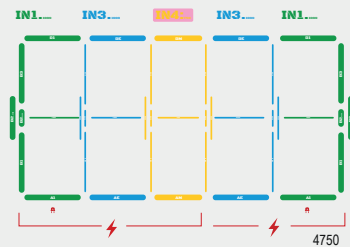

RASTER 500 MM

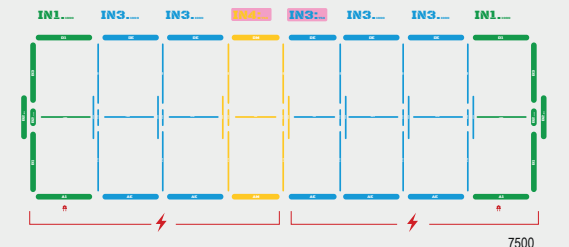
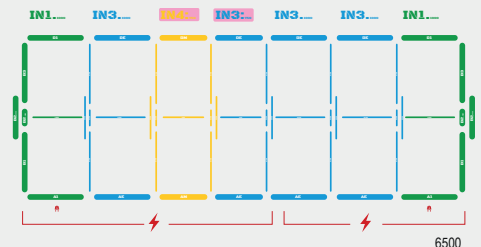
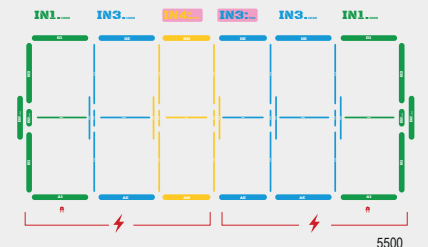
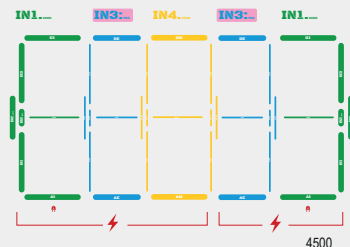

RASTER 250 MM

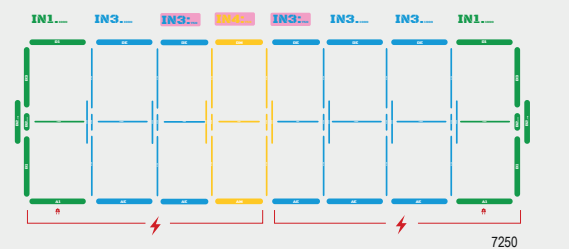
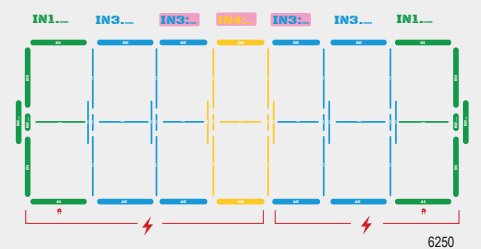
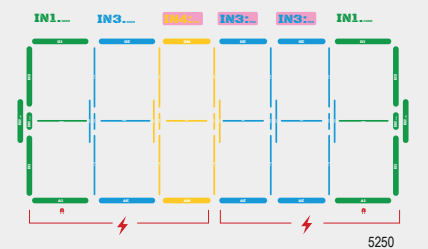
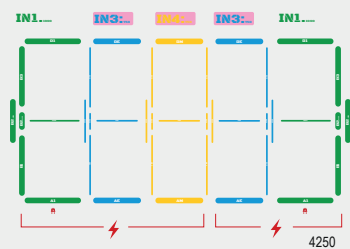

## // AP\_120

Exemplarische Ansicht bei einer Rahmenbreite von 4 m.  
Die Breite ist variabel und modular aufgebaut und kann bei Bedarf auf die Wunschbreite angepasst werden.

Example view with a frame width of 4 m.  
The width is variable and modular in design and can be adjusted to the desired width as required.

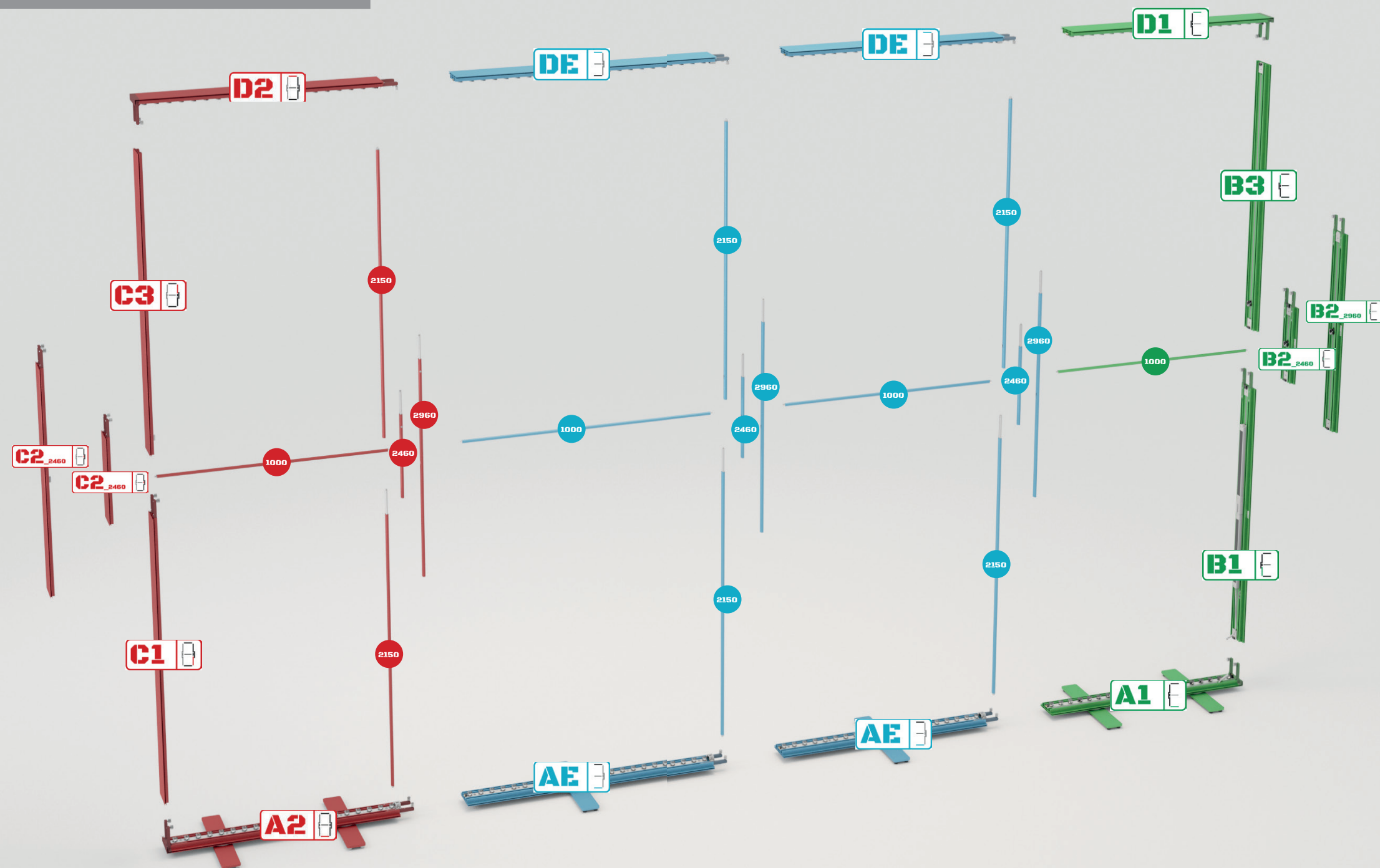

## // AP\_120

Durch die Verwendung verschieden langer Mittelstücke (C2) ergeben sich drei Bauhöhen 2150 / 2460 / 2960mm.

By using center pieces (C2) of different lengths, three construction heights of 2150 / 2460 / 2960 mm can be achieved.

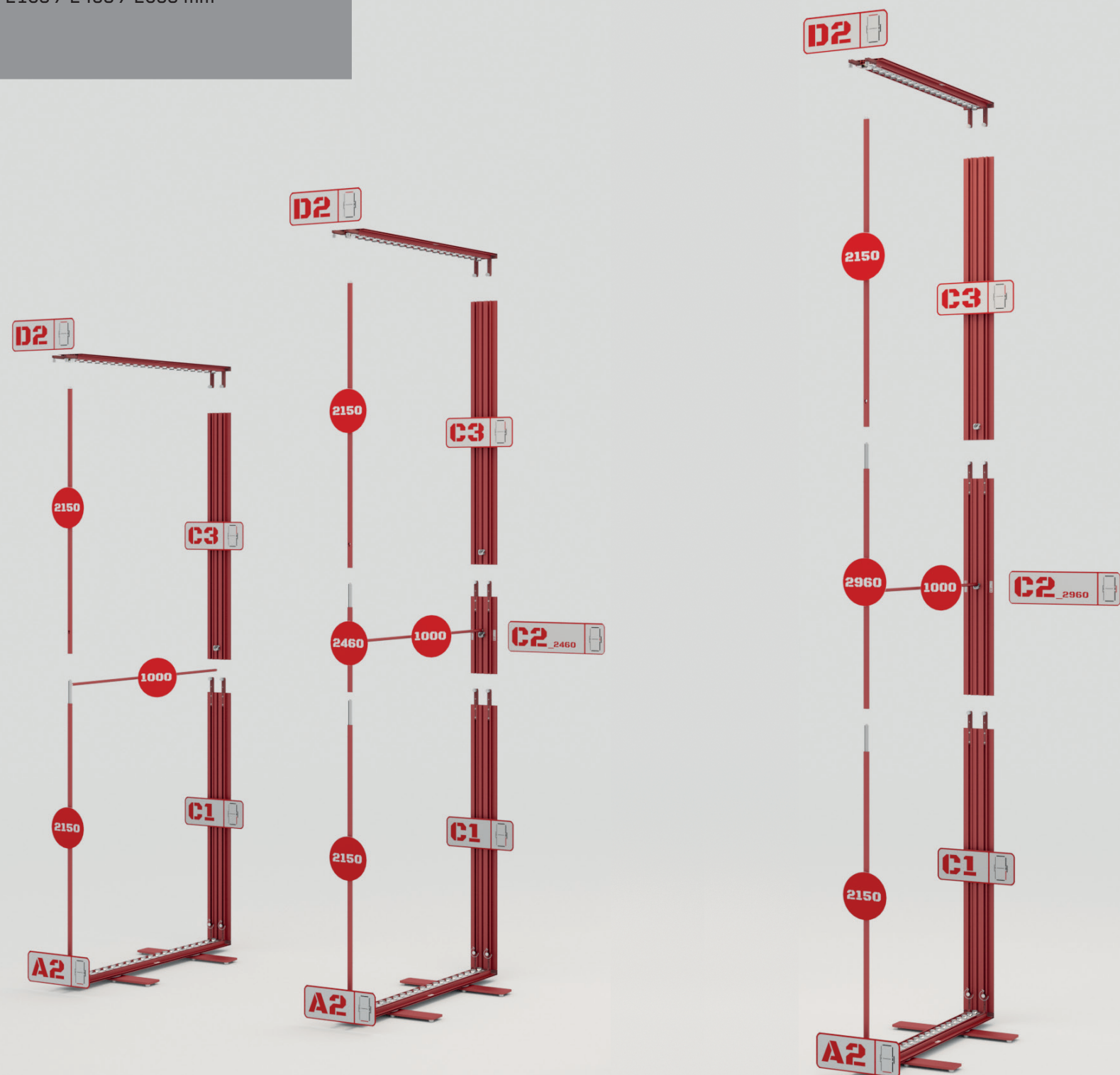

## // AP\_120

Exemplarischer Aufbau eines Grundmoduls.

Example assembly of a basic module.

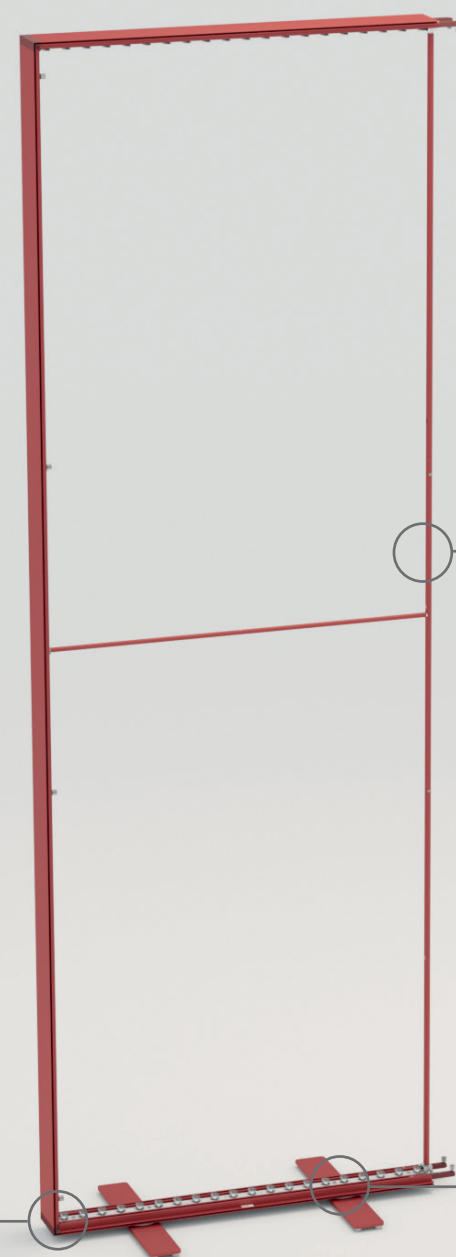

Die vertikale Aussteifung wird auf Wunschhöhe zusammengesteckt. Die Montage erfolgt durch das Eindrehen in die vorgesehene Halterung.

The vertical bracing is assembled at the desired height. Installation is carried out by screwing it into the designated bracket.

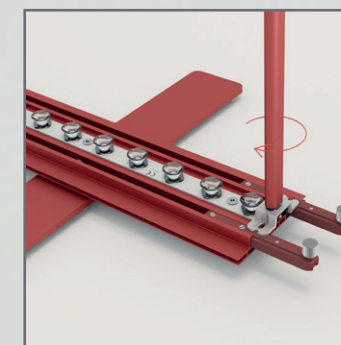
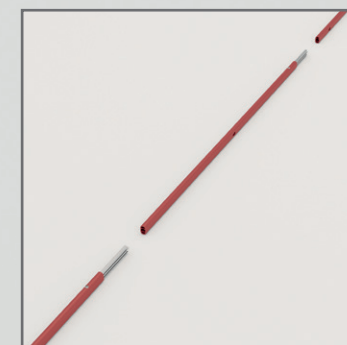

Die Profile werden nach dem Zusammenstecken an allen Verbindungen durch Drehen der Rändelschrauben fixiert.

After assembly, the profiles are secured at all joints by turning the knurled screws.

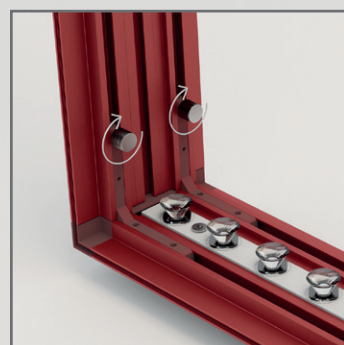
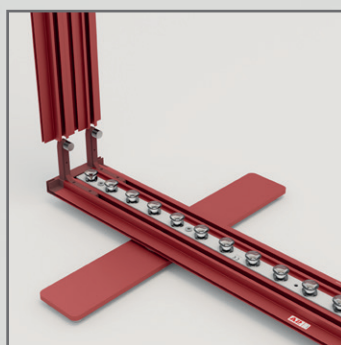

Fußplatte um 90° drehen  
Turn the footplate by 90°

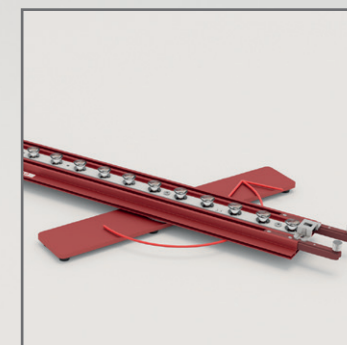

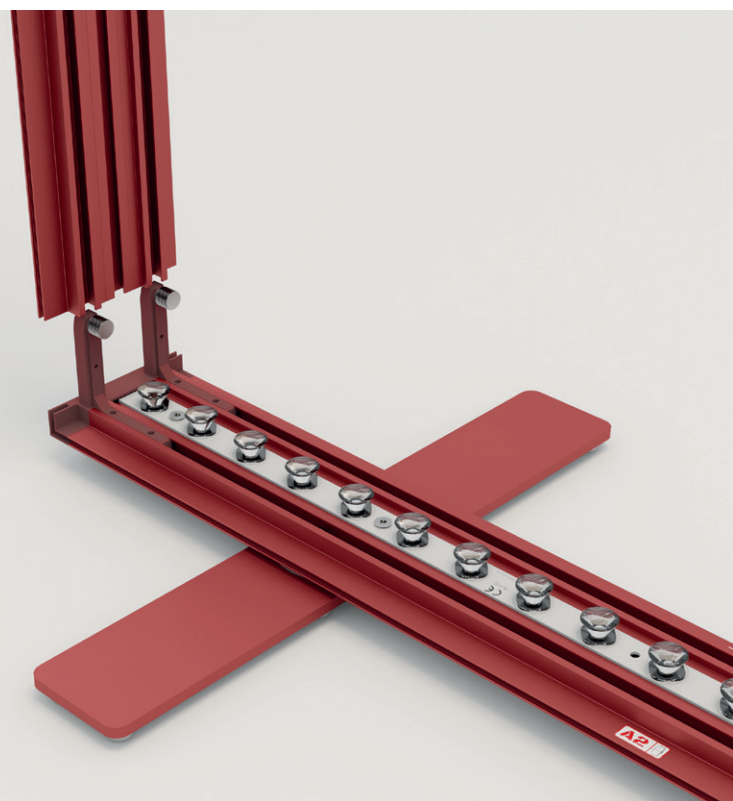

Die Profile werden nach dem Zusammenstecken an allen Verbindungen durch Drehen der Rändelschrauben fixiert.

After assembly, the profiles are secured at all joints by turning the knurled screws.

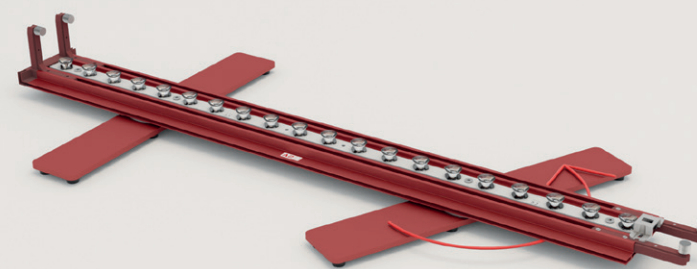

Fußplatte um 90° drehen  
Turn the footplate by 90°

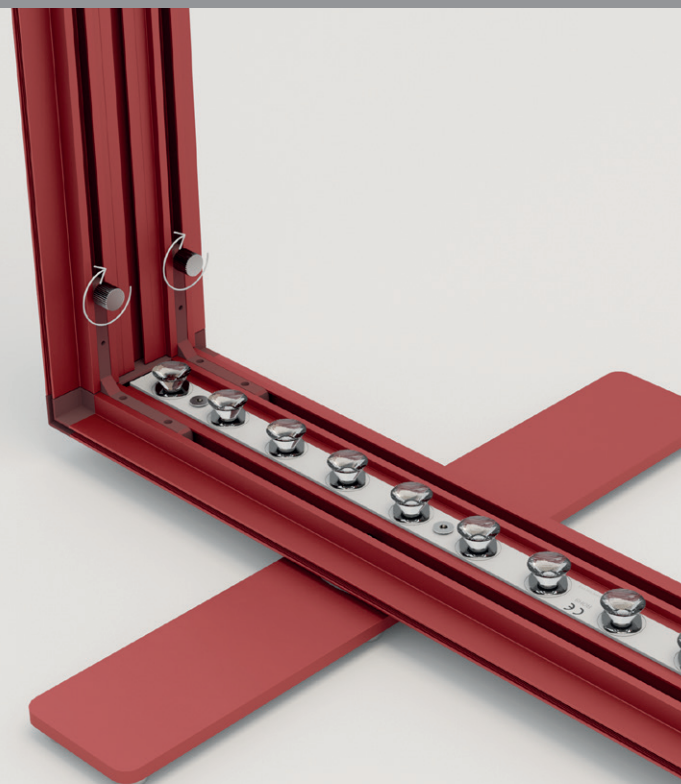

Die vertikale Aussteifung wird auf Wunschhöhe zusammengesteckt. Die Montage erfolgt durch das Eindrehen in die vorgesehene Halterung.

The vertical bracing is assembled at the desired height. Installation is carried out by screwing it into the designated bracket.

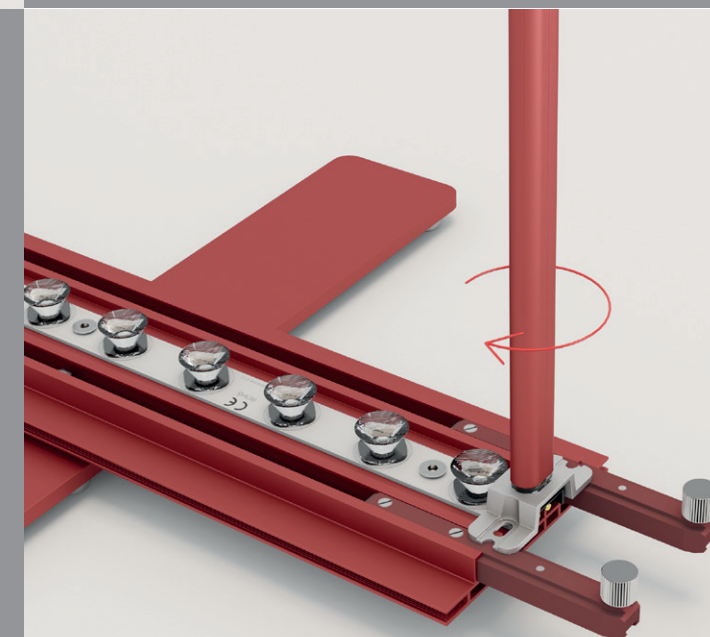

## // AP\_120

Die horizontalen Aussteifungen werden ab einer Bauhöhe von 2460mm für eine bessere Stabilität im Versatz eingehangen.

The horizontal bracing is hooked into the offset for better stability from a construction height of 2460 mm.

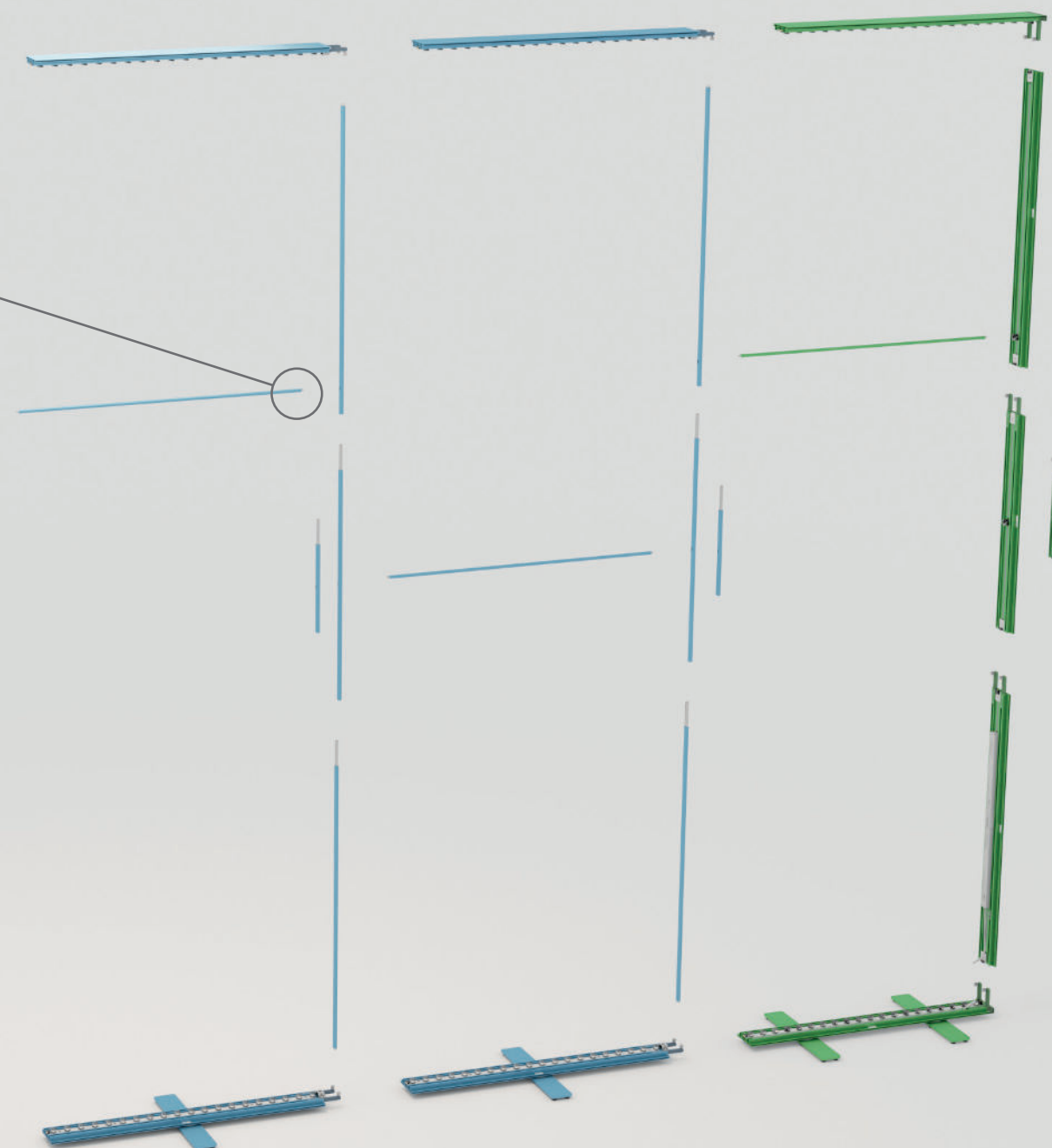
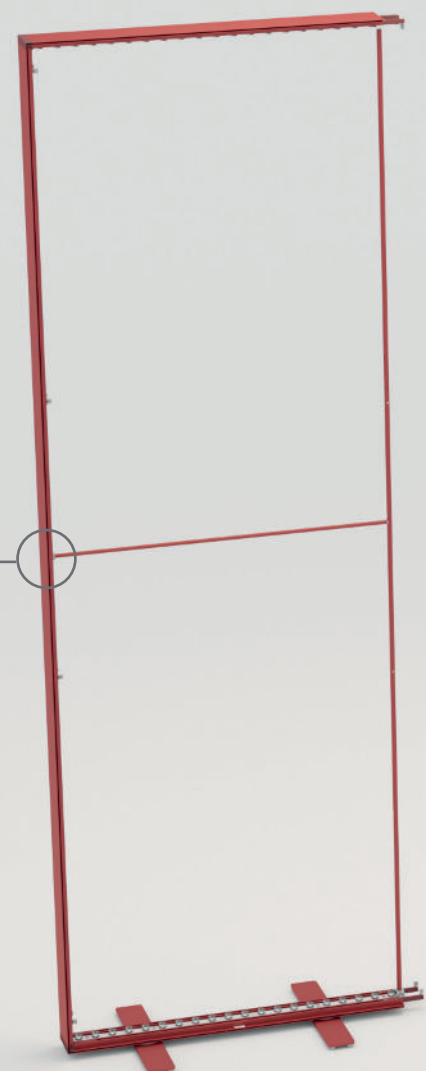
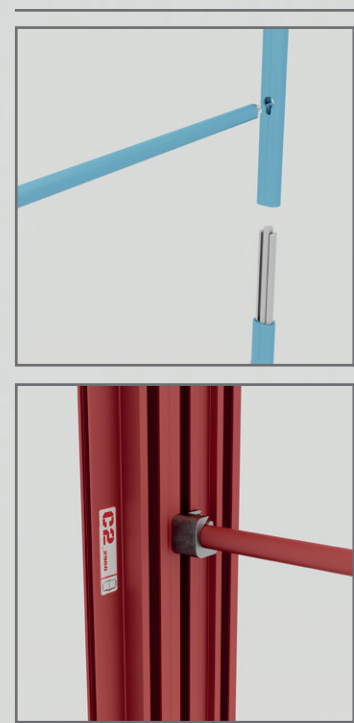

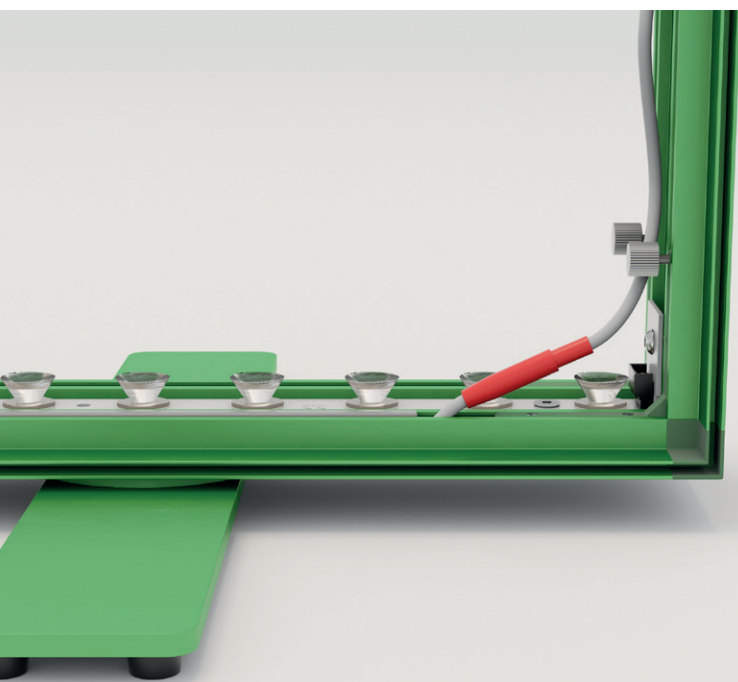

Die innenliegende Leitung an der Eckverbindung (A1 und B1) zusammenstecken. Der beiliegende Schuko stecker ist mit dem nach außenführenden Kabel zu verbinden.

Connect the internal cable at the corner connection (A1 and B1). The enclosed Schuko plug must be connected to the cable leading to the outside.

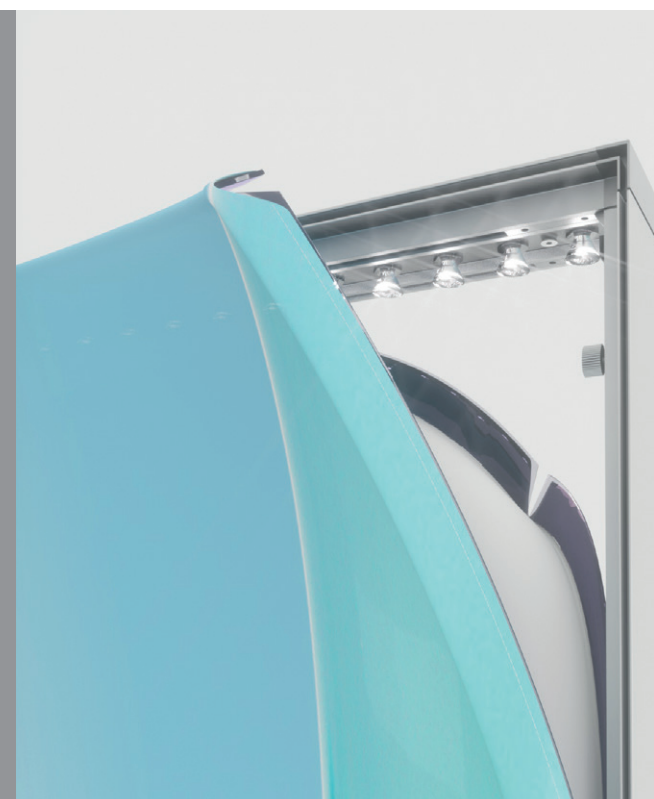

Beginnen Sie beim Einsetzen des Textils mit den Ecken. Achten Sie darauf, den Gummikeder zuvor einmal umzuschlagen. Verwenden Sie hierzu Handschuhe.

When inserting the fabric, start with the corners. Pay attention to turn over the silicon edge before. Use gloves for it.

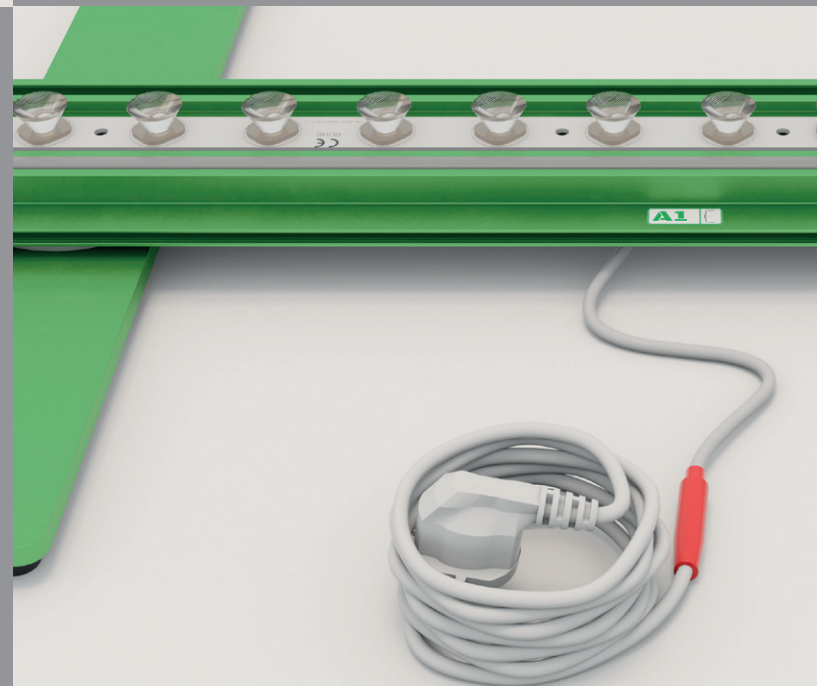

## // AP\_120

### Anbau - und Verbindungsteile Mounting and connecting parts

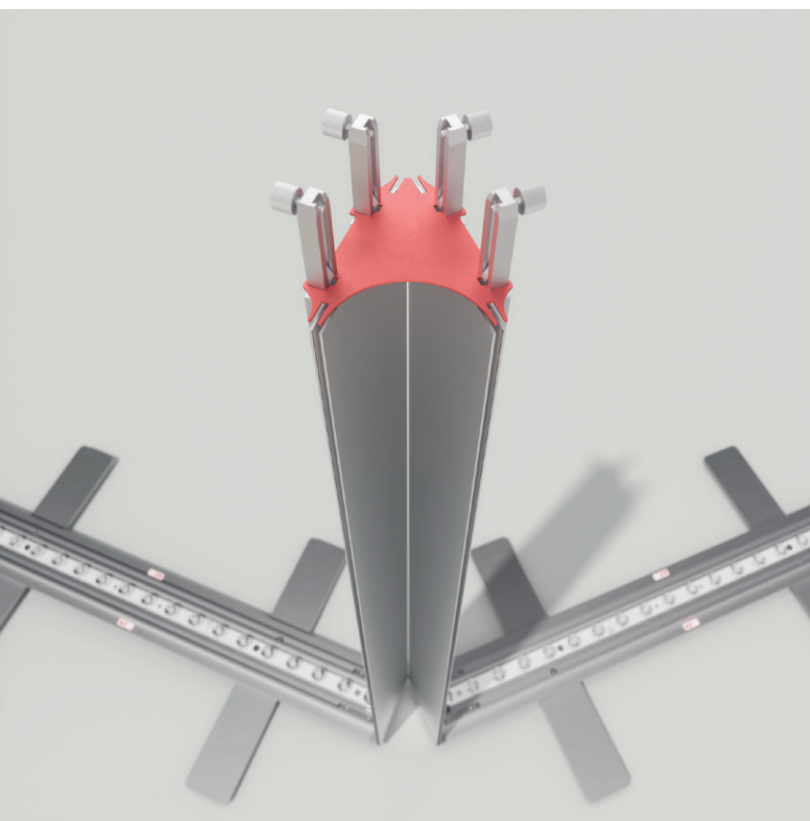

Verbindung von zwei AP\_120 Rahmen mit einem 45 Grad Winkel.

Connection of two AP\_120 frames at a 45-degree angle.

V-ZB-AP120-45G

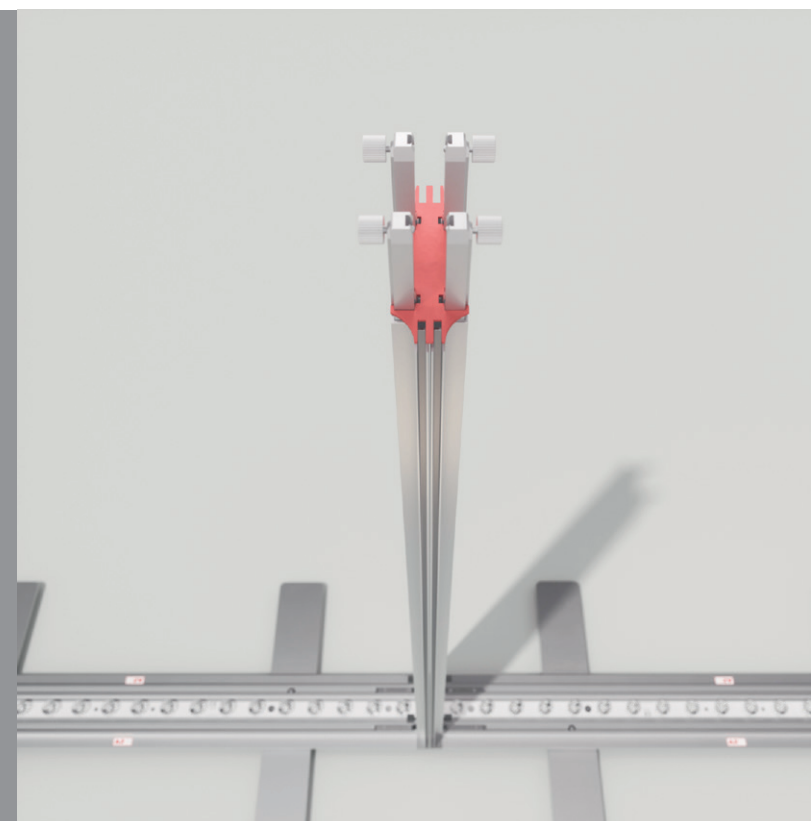

Verbindung von zwei AP\_120 Rahmen mit einem 180 Grad Winkel.

Connection of two AP\_120 frames at a 180-degree angle.

V-ZB-AP120-180G

Verbindung von zwei AP\_120 Rahmen mit einem 90 Grad Winkel.

Connection of two AP\_120 frames at a 90-degree angle.

V-ZB-AP120-90G

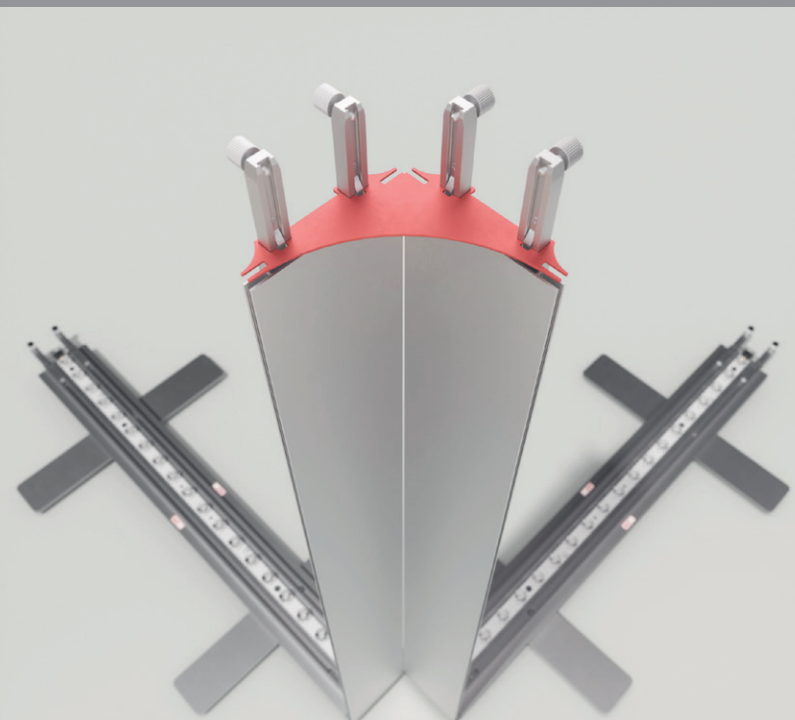

Verbindung von bis zu vier AP\_120 Rahmen mit je 90 Grad Winkel.

Connection of up to four AP\_120 frames, each with a 90-degree angle.

V-ZB-AP120-360G

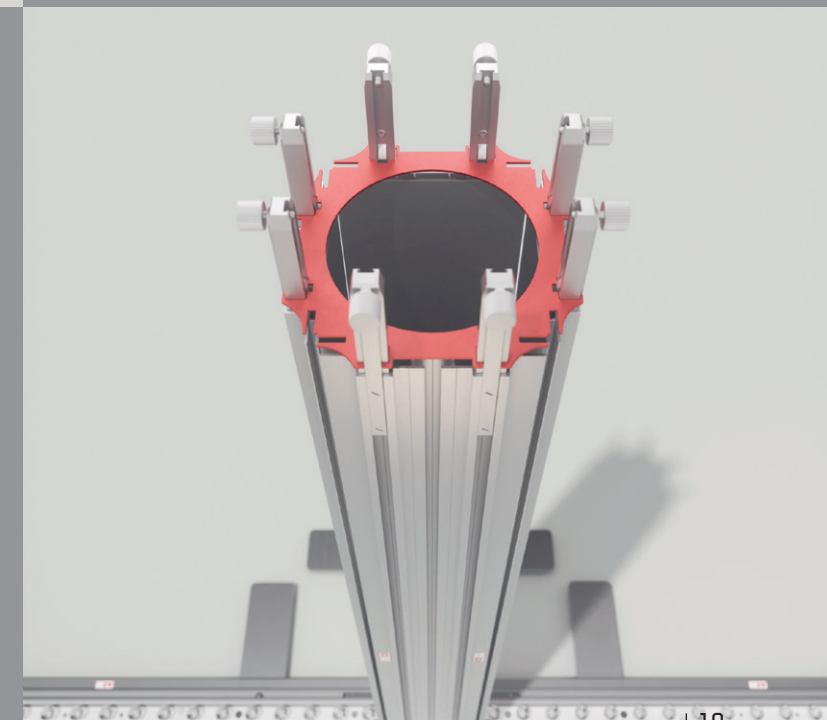

// AP\_120

**Anbau - und Verbindungsteile**  
Mounting and connecting parts

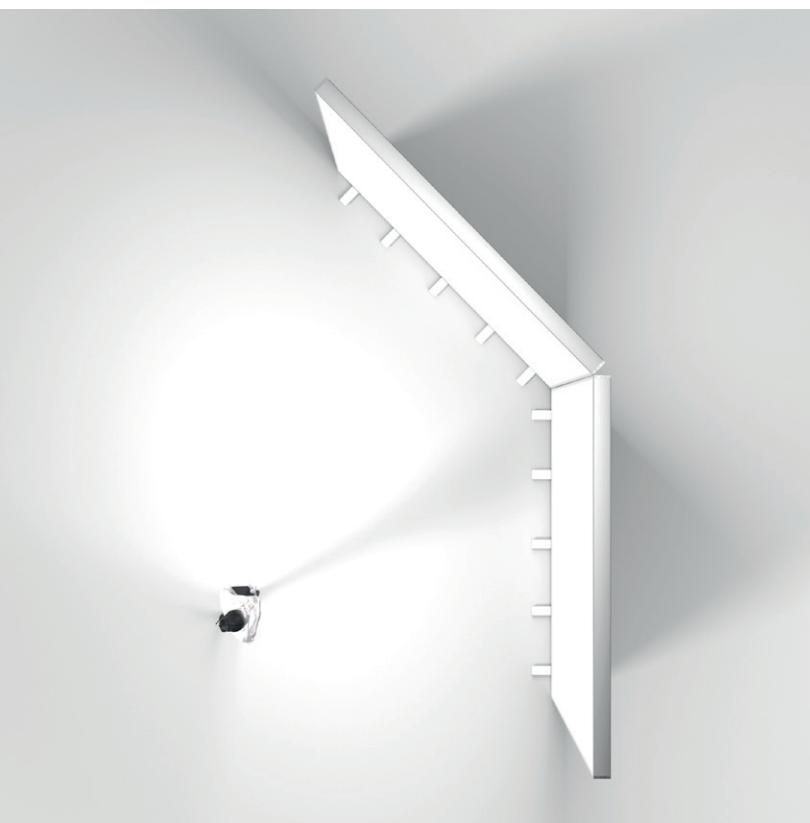

Ansicht 45 Grad Winkel.  
45-degree angle view.

V-ZB-AP120-45G

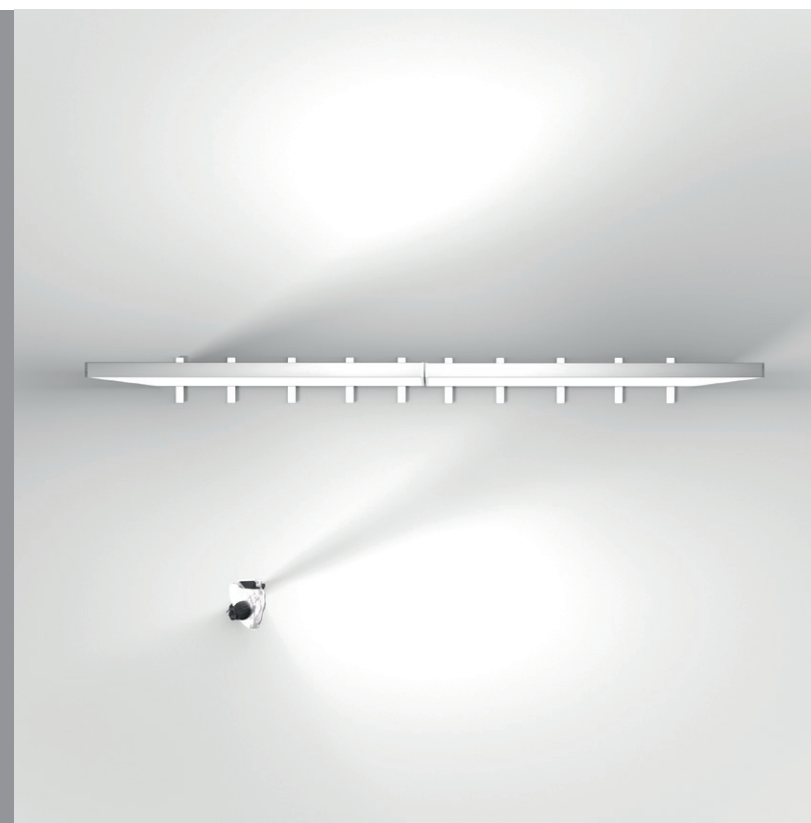

Ansicht 180 Grad Winkel.  
180-degree angle view.

V-ZB-AP120-180G

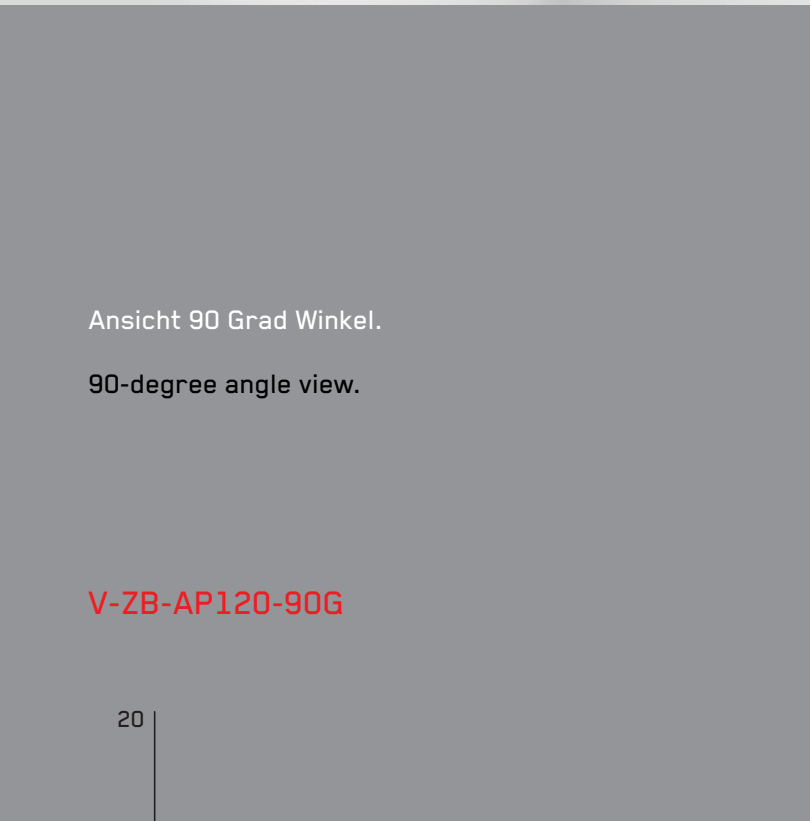

Ansicht 90 Grad Winkel.  
90-degree angle view.

V-ZB-AP120-90G



Ansiicht 360 Grad Winkel.  
360-degree view angle.

V-ZB-AP120-360G

